

Article number: 2072168M1615LB

Description: E+G indexing plunger
GN 721.5-8-M16x1,5-LB

Measures

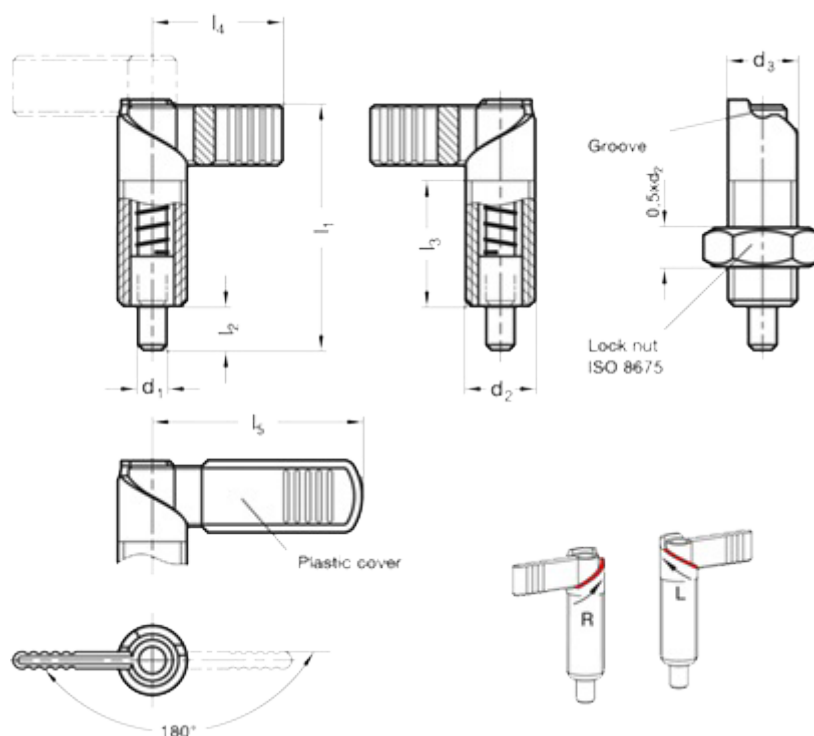

d1 = 8
d2 = M16x1.5
d3 = 16
l1 = 56
l2 = 10
l3 = 30
l4 = 32
l5 = 42

Spring load in N end = 11
Spring load in N top = 29
Weight in (g) = 166